

USER MANUAL

IPS-12RS

Document version: AEM.10.04.23

112 ^{IPS} >



CONTENTS

1.

1. SAFETY

1.1 Aim of this documentation	4
1.2 Accentuations in the text.....	4
1.3 Hazardous operating conditions	4
1.3.1 Responsibilities of the operator	4
1.3.2 Minimizing hazards	5
1.4 Safety.....	5
1.5 Inspection of goods.....	5
1.6 Installation.....	5
1.7 Operation	6
1.8 Maintenance	6
1.9 Disposal/recycling.....	6

2.

2. IPS-12 PRODUCT DESCRIPTION

2.1 Product overview	7
----------------------------	---

3.

3. OPERATION INSTRUCTIONS

3.1 Loading pump	8
3.2 Basic screen.....	9
3.3 Advanced settings	12



ATTENTION!



**DON'T USE
WITHOUT
GROUNDING IN
ELECTROSPINNING PROCESS**

SAFETY

1. SAFETY

1.1 AIM OF THIS DOCUMENTATION

This document is included at the delivery and is therefore an integral part of the equipment. It describes the machine's design and configuration at the time of the delivery.

For your personal safety reasons, please study this documentation before installing or operating the equipment.

Instructions related to safety, handling, operation and maintenance are to be followed.

Noncompliance can result in serious personal injury or damage to the machinery and may invalidate manufacturer's liabilities and warranties.

This documentation includes guidance for:

- Installers
- Operators
- Maintenance staff

Please retain this documentation throughout the lifetime of the equipment.

1.2 ACCENTUATIONS IN THE TEXT

Caution! Identifies hazards that could lead to damage of the equipment.

Warning! Indicates "potentially" hazardous situations which could result in damage of the equipment serious personal injury or death.

Danger! Indicates "imminently" hazardous situations, which could result in damage of the equipment, serious personal injury or death.

Attention! Indicates important information or instruction that requires special attention.

1.3 HAZARDOUS OPERATING CONDITIONS

Operation of the system is deemed to be hazardous, if:

- Is not operated within the permitted operating parameters (see technical specifications)
- Is operated outside the scope of 'normal' use (see intended use)

1.3.1 RESPONSIBILITIES OF THE OPERATOR

It is the responsibility of the operator of the system to ensure that all personnel engaged with installation, operation, maintenance and service of the equipment have read and understand the relevant sections of this manual.

SAFETY

1.3.2 MINIMIZING HAZARDS

To ensure risk to personnel is minimised:

- Ensure that all activities relating to this equipment are carried out by qualified and authorised staff only.
- Identify and prevent potential safety hazards in the environment. To ensure a failure-free operation:
 - Keep this manual ready to hand with the unit.
 - Use the machine as intended only.
 - Only use the machine if it is fully functional.
 - Check the condition of the machine before using.
 - Check the machine on operational efficiency at regular intervals.
 - Carry out maintenance and testing at the prescribed intervals.

1.4 SAFETY

This equipment conforms to the appropriate European regulations and directives and is designed and manufactured to be safe and reliable in operation.

Continued safety and reliability is entirely dependent on correct handling, installation, operation and maintenance of the equipment supplied.

1.5 INSPECTION OF GOODS

Check for transportation damage! Continue the use of this product only if you assess it as being undamaged and faultless. Any damage must be recorded by the forwarder at the time of delivery and reported to the supplier of the equipment at the earliest opportunity.

Please check the condition of the equipment carefully for damage upon receipt.

Warning! Only use tested and certified lifting equipment to offload and position the unit.

Warning! If a fork lift is used to move the unit, please ensure the load is evenly balanced.

1.6 INSTALLATION

Attention! Installation, testing, commissioning preventative and corrective maintenance must be carried out by a qualified person or under the supervision of a qualified person.

A qualified person (mechanical) is defined in this manual as:

- Has completed the appropriate health and safety training.
- Has read and is familiar with the contents of this manual.
- Is professionally competent to commission and service this type of equipment.

SAFETY

1.7 OPERATION

Caution! Do not expose the unit to ambient temperature that exceeds 60°C/132°F for long period of time. This may damage the internal components!

Warning! Please do not let any pumping liquid leakage and spread on any parts of the machine as syringe, syringe pump, PE distribution pipes, fitting parts, cabin base etc.

Warning! Please use protective materials as gloves, masks and glasses while working with harmful chemicals.

1.8 MAINTENANCE

Caution! Defective electrical components and defective wiring must be replaced immediately. The equipment must not be operated until the defect has been repaired and the unit has been retested.

1.9 DISPOSAL/RECYCLING

When the unit is no longer in use and taken out of service - dismantle the unit and recycle the components according to the local regulations.

PRODUCT DESCRIPTION

- 4.3" Resistive Touch TFT LCD screen
- Microcontroller software
- User friendly interface
- High precise pumping
- Adjustable flow rate even during process



SYRINGES

CAPACITY	1
TYPE	Glass, plastic, steel
MIN SIZE	Hamilton 0.5 μ l (ID:0.103mm)
MAX SIZE	Monoject 140 ml (ID:38mm)

FLOW RATE

MIN	17,89 μ l/min (Hamilton 0.5 μ l)
MAX	121,51 ml/min (140 ml Monoject Syringe)
MOTOR TYPE	Stepper Motor
MOTOR DRIVE CONTROLLER	Microcontroller with Microstep Drive
STEP RESOLUTION (TRAVEL/MICROSTEP)	357 nm/ μ step

STEP RATE

MIN	10 sec/ μ step
MAX	200 μ sec/ μ step

LINEAR SPEED RATE (PUSHER TRAVEL RATE)

MIN	2,14 μ m/min
MAX	107,14 μ m/min
LINEAR FORCE	20 kg
CONNECTORS	Wi-fi(optional)
RECIPE SAVE-RECALL	Yes
POWER SUPPLY	12 VDC 1A (110-240 VAC adapter included)
DIMENSIONS	W:211 L:170 H:137 mm
WEIGHT	2.2 kg

ENVIRONMENTAL SPECIFICATIONS

OPERATING TEMPERATURE	Between -10 and 50 ($^{\circ}$ C)
STORAGE TEMPERATURE	Between -30 and 85 ($^{\circ}$ C)
OPERATING HUMIDITY	RH 10% - RH 90% (not condensed)
STORAGE HUMIDITY	RH 10% - RH 90% (not condensed)

OPERATION INSTRUCTIONS

3.1 Loading Pump

- Parts of the pump:

1. Pushing Block
2. Release Button
3. Rod
4. End Plate
5. Linear Rail
6. Syringe Holding Block (V-Slot)
7. Syringe Clamp

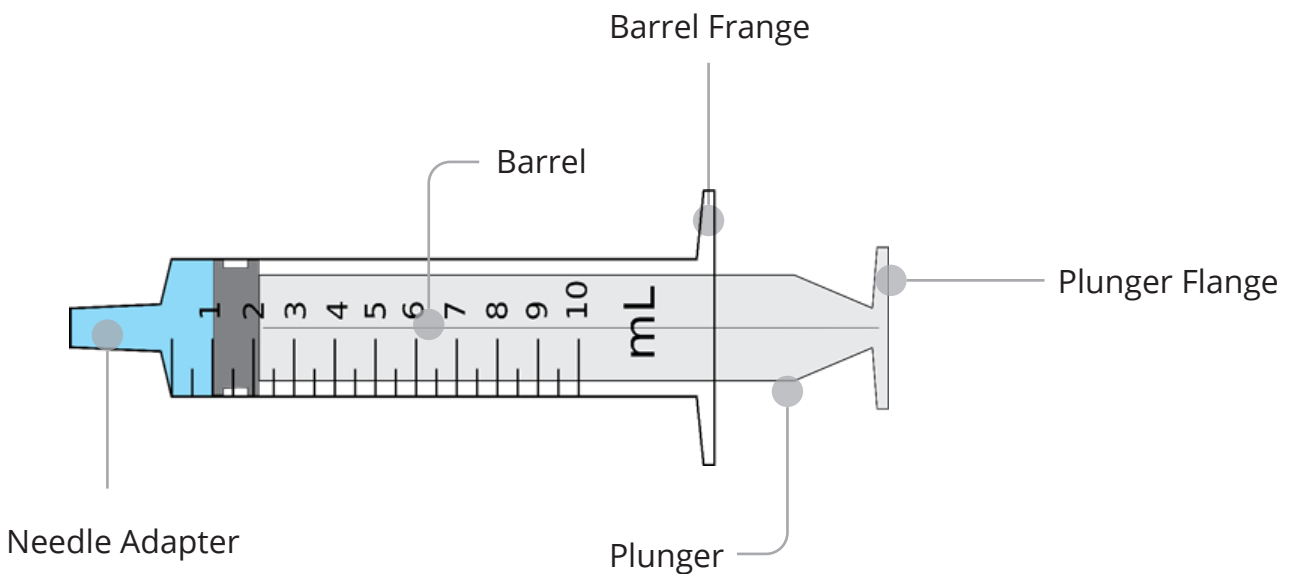
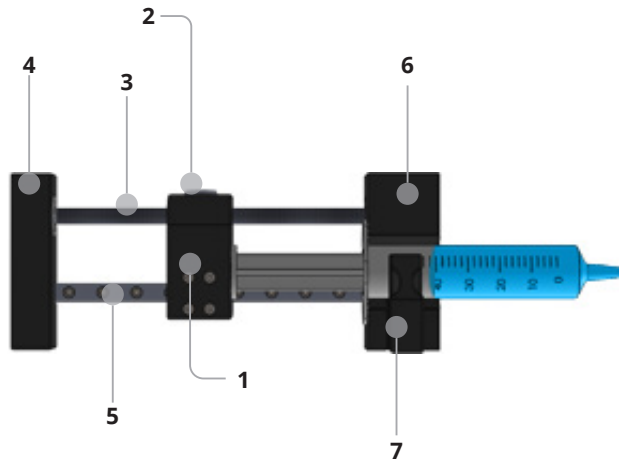

1. Press the release button and move the block to the approximate length of the syringe.
2. Move the syringe clamp above the syringe holding block. Turn it a 180 degree round and then lower it onto the syringe holding block. Load the syringe with the solution. Place the syringe in V-slot while the barrel flange withstand the edges of the syringe holding block from both sides.
4. Turn the syringe clamp back to its original position and lower it onto the syringe barrel to fit the syringe in V-slot.
5. Press the release button to slide the pushing block against the syringe plunger. Release the release button to fix the final position of the syringe barrel.

OPERATION INSTRUCTIONS

3.2 BASIC SCREEN

SCREEN -1: Main Page

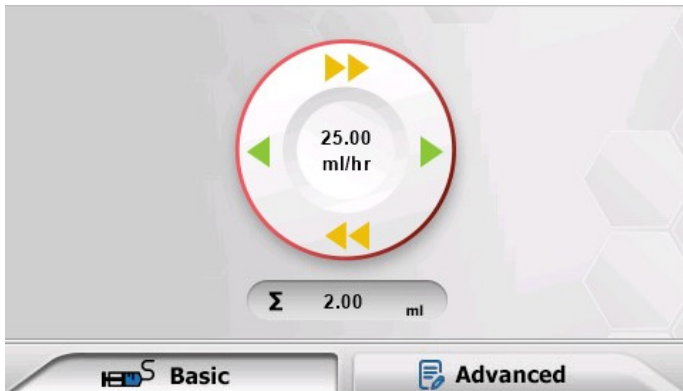

This is the beginning page of operation system that has operation parameters.

3.3. PUMP SETTINGS

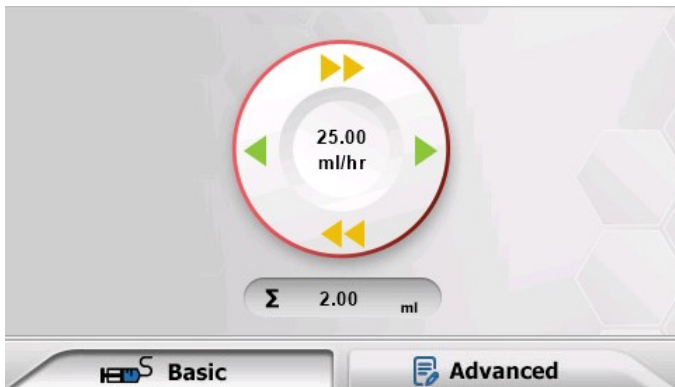

PUMP OPERATION PARAMETERS

Pressing in the middle of the pump controller next screen will appear.

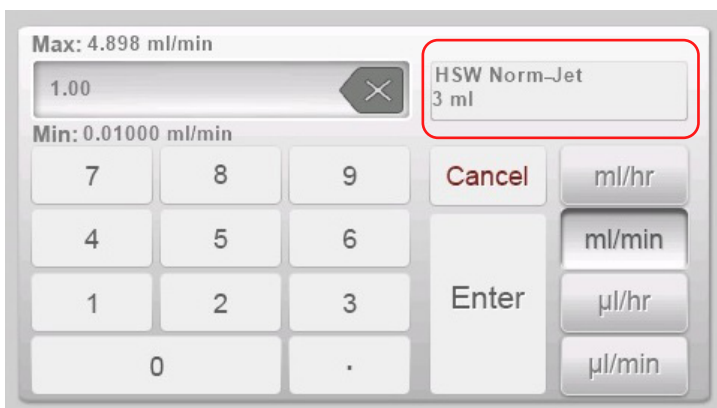

Press to select syringe type or to enter custom syringe parameters.

OPERATION INSTRUCTIONS

SCREEN -2: Syringe Type

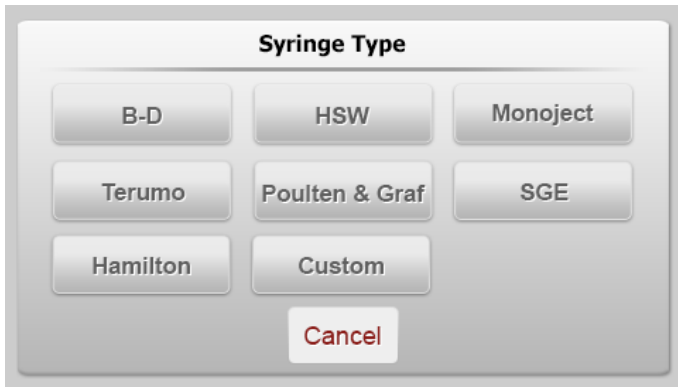

This screen is for entering the syringe diameter to system. Many of the international syringe types are already saved in the database. If you are using one of these brands you can choose it and then the second screen will be for choosing the volume.

SCREEN -2.1: Syringe Volume



After choosing syringe model the screen of syringe volume will be opened. The operation system will work with true diameter according to the data of syringe types and volumes.

SCREEN -2.2: Custom Diameter Entry

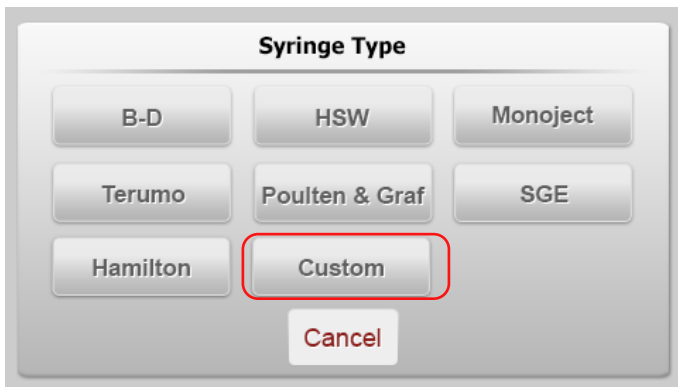

If you don't use any of the model that already described in the operation system, you will need to write it directly. On the above screen you can write the diameter of syringe manually by the unit of millimeters.

SCREEN -3: Defining Flow Rate Unit

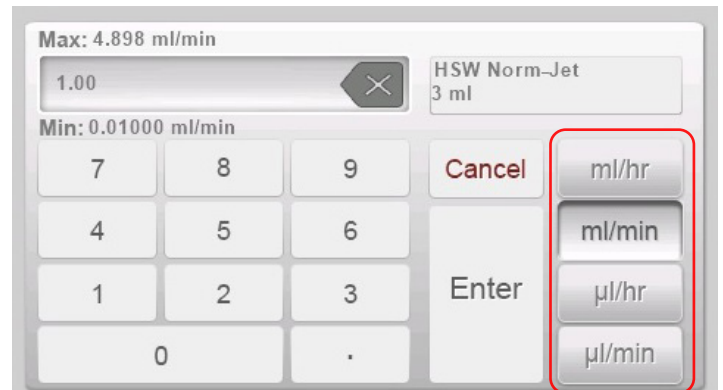

That screen is for choosing the unit of flow rate. The pushing rate will be changed by the flow rate by pump automatically.

OPERATION INSTRUCTIONS

SCREEN -4: Defining Flow Rate

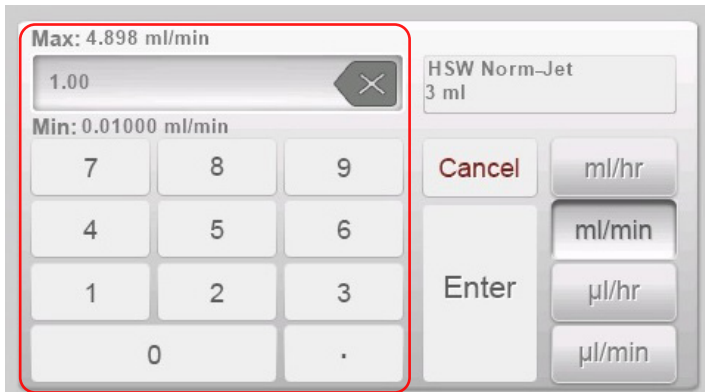

The flow rate according to the defined unit can be set from the shown part in the screen.

SCREEN -5: Purging

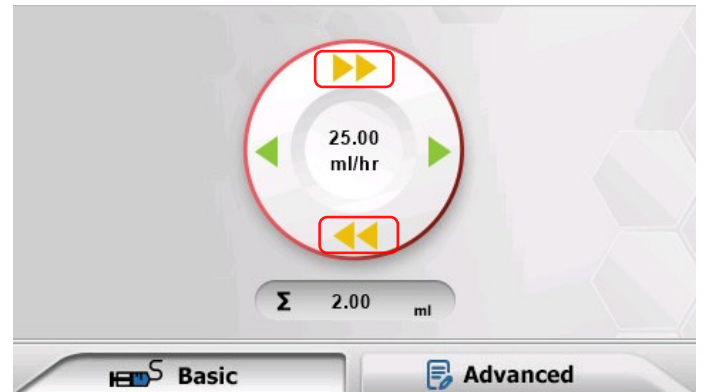

After the syringe is placed in the infusion system of the pump, if you need purging the syringe you can use the arrow buttons shown above. The purging can be done for both directions.

SCREEN -6: Total Volume

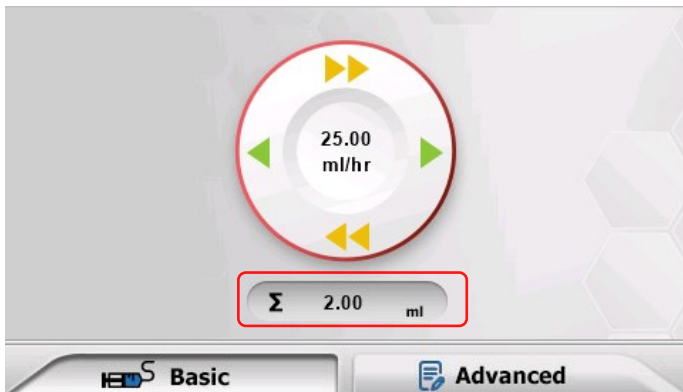

Here to enter existing volume in the syringe.

SCREEN -7: Starting Pumping

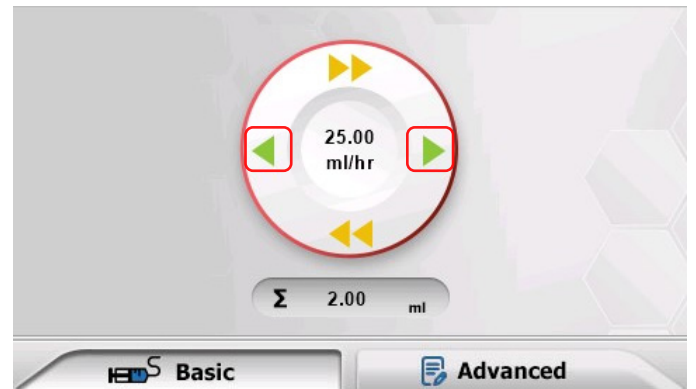

If you tap the button on the right side of the screen, the pump will begin the infusion. If you tap the button on the left side, it will start to withdraw.

Note: Withdrawal function is only available in IPS 12R and IPS 12RS.

OPERATION INSTRUCTIONS

3.4 ADVANCED SCREEN (ONLY FOR IPS12S AND IPS12RS)











On this screen you can prepare a recipe consisting of 5 steps. It is possible to set up 3 different functions for each step.



WARNING

Total volume calculation is not performed on this screen. Please check that the total volume in the syringe you are using is compatible with the volumes in the prescription steps.

-  The volume to be determined in the relevant step allows the pump to infuse in accordance with V(ml) and flowrate (ml/hr).
-  The volume to be determined in the relevant step allows the pump to withdraw in line with V(ml) and flowrate (ml/hr). **Note: Withdrawal function is only available in IPS 12RS.**
-  Allows the pump to wait in line with the time to be determined in the relevant step.
-  Allows to start the recipes.
-  Allows pausing the current recipe operation.
-  Ensures that the stopped recipe operation is continued
-  Stops the current recipe operation.
-  Shows which line the pump is processing.



Inovenso Inc.
46 Concord Ln,
Cambridge, MA 02138,
USA
usa@inovenso.com